

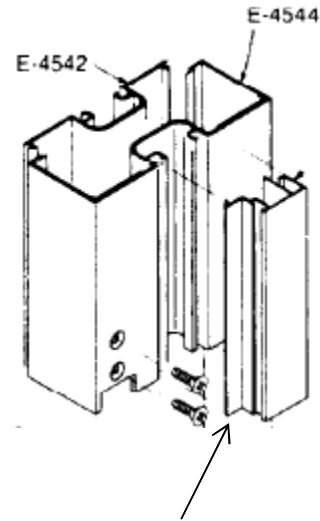

Aluminum Storefront Door – Installation into Existing Opening

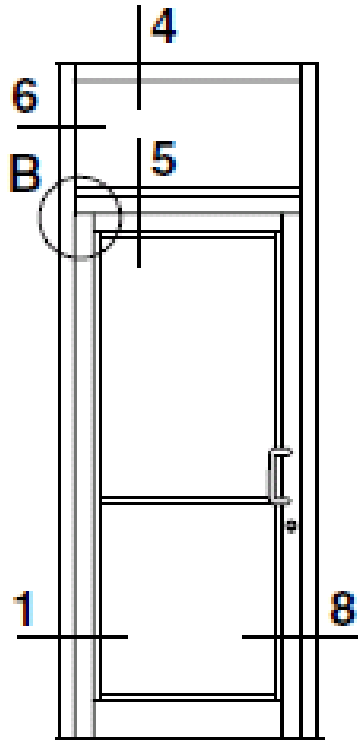

Snap-In / Removable Door Stop

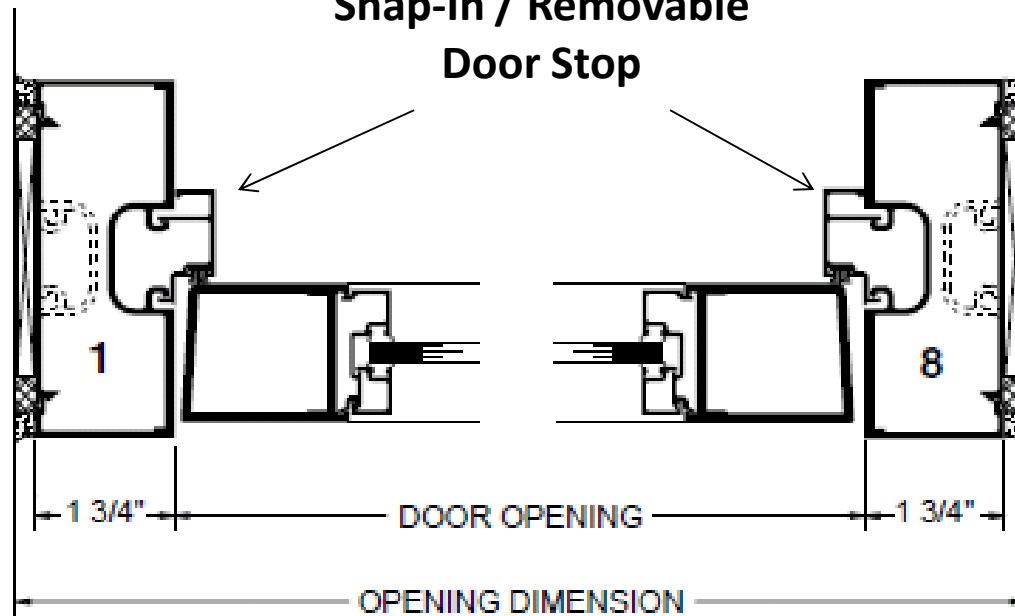



Aluminum Storefront Door – Installation into Existing Opening Expansion Bolt for Masonry Application

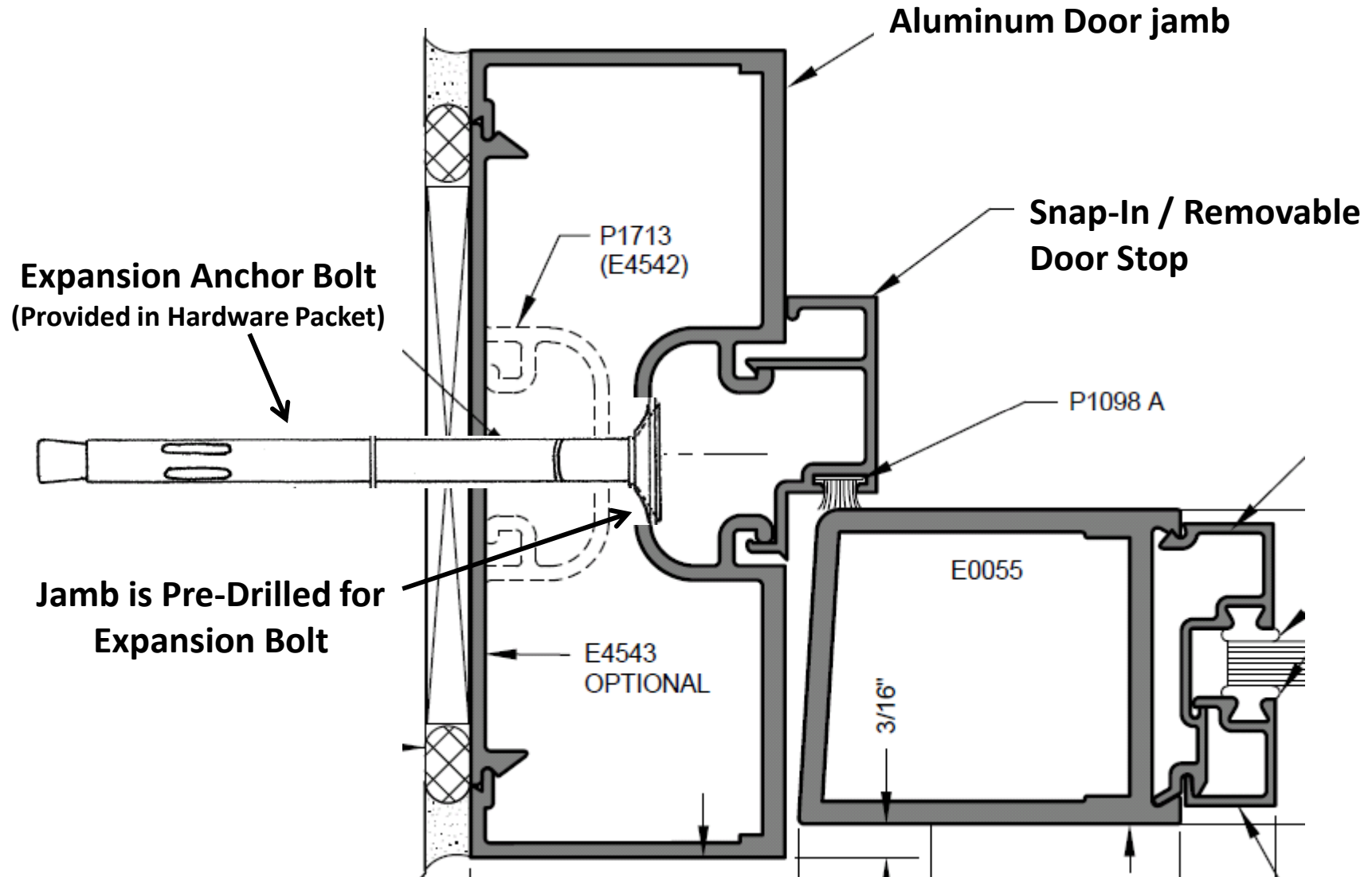



Aluminum Storefront Door – Installation into Existing Opening *TAPCON* Fastener for Masonry Application

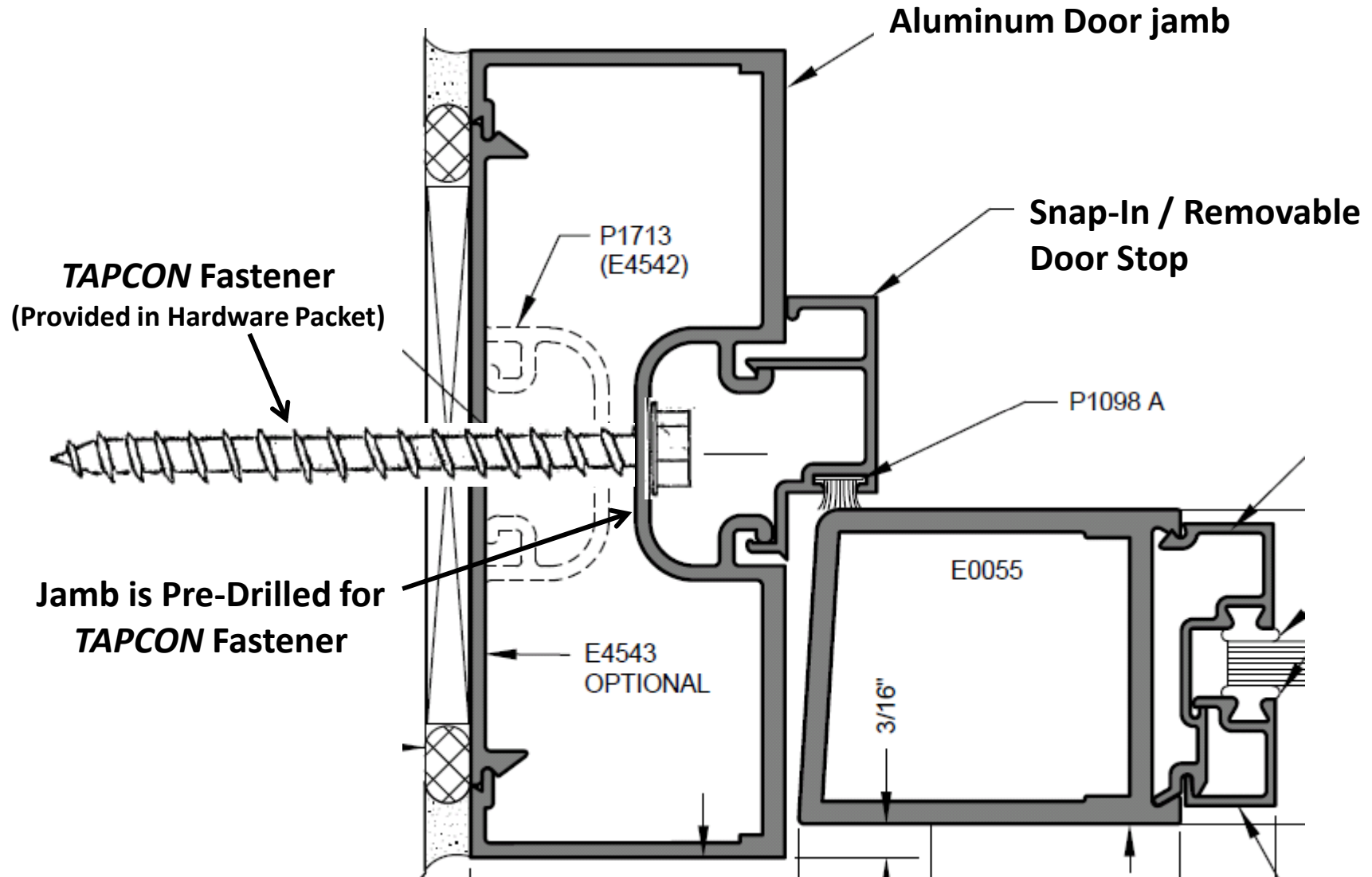



Aluminum Storefront Door – Installation into Existing Opening Self-Drilling Fastener for Steel Framed Opening Application

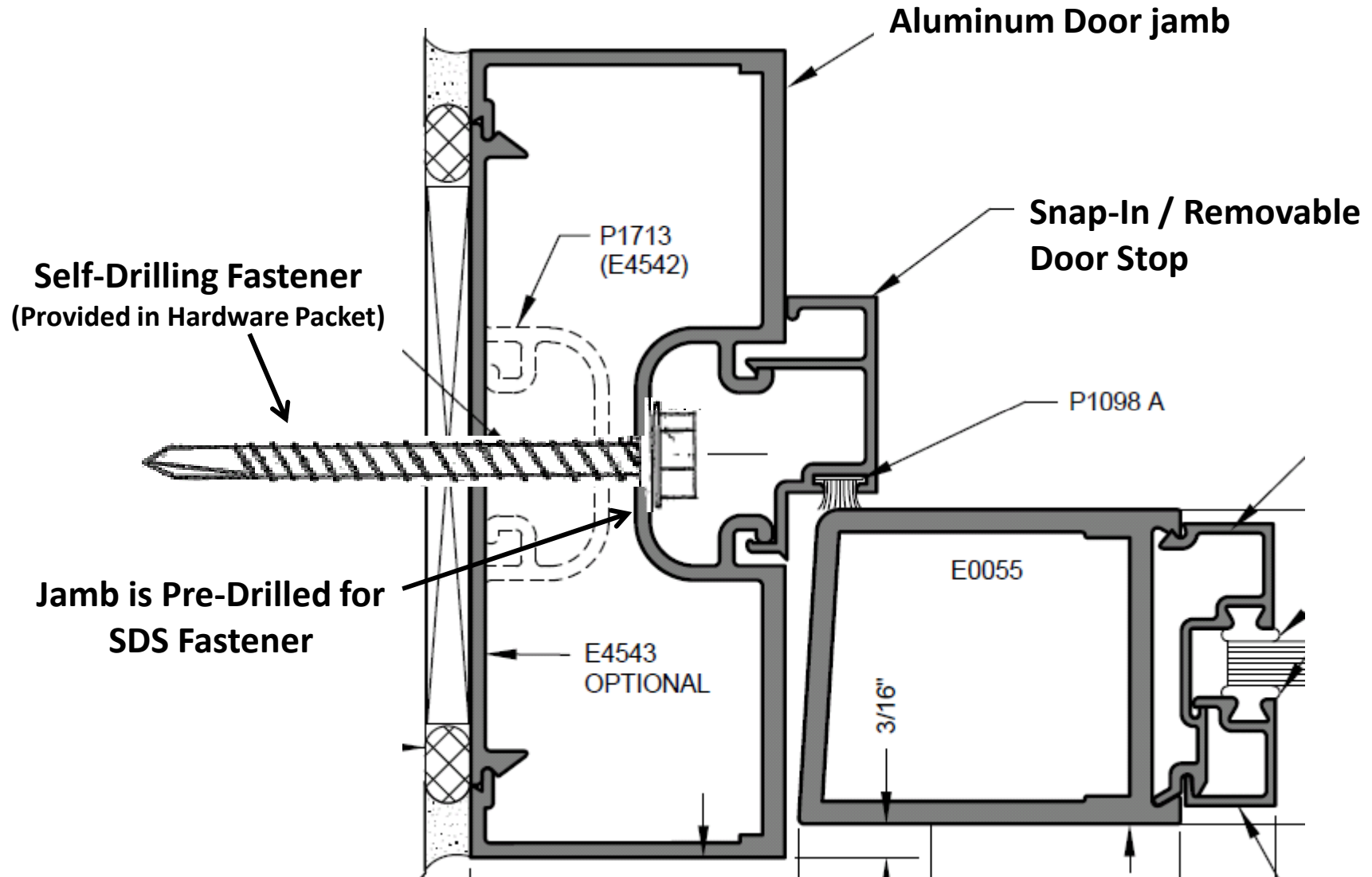



Aluminum Storefront Door – Installation into Existing Steel Opening Self-Drilling Fastener Thru Framed Opening into Aluminum Frame

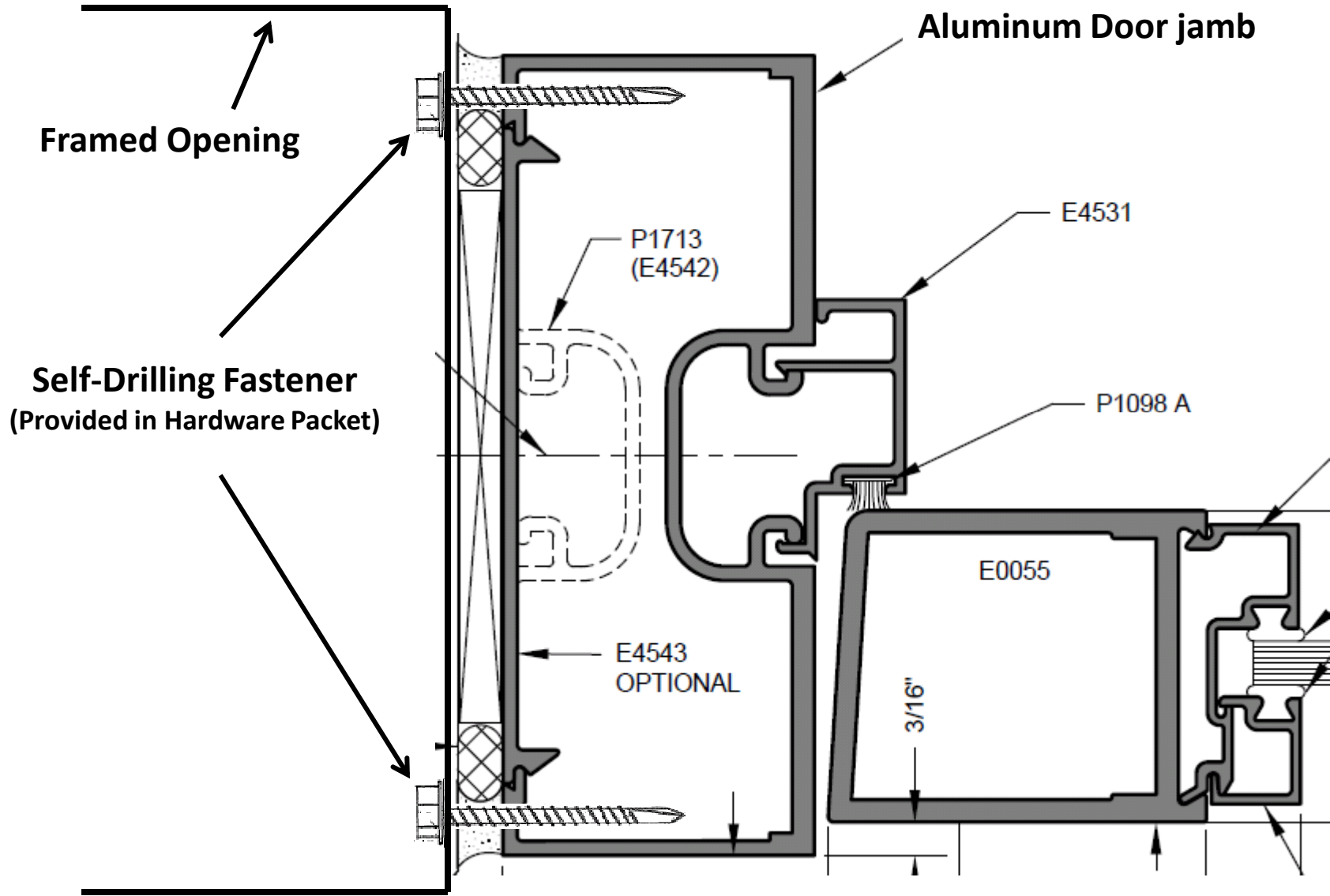



Aluminum Storefront Door – Installation into Existing Opening Wood Lag Bolt/Screw for Wood Framed Opening Application

